

## FEATURES

- Control Inputs  $V_{IH}/V_{IL}$  Levels Are Referenced to  $V_{CCA}$  Voltage
- $V_{CC}$  Isolation Feature – If Either  $V_{CC}$  Input Is at GND, Both Ports Are in the High-Impedance State
- Overvoltage-Tolerant Inputs/Outputs Allow Mixed-Voltage-Mode Data Communications
- Fully Configurable Dual-Rail Design Allows Each Port to Operate Over the Full 1.2-V to 3.6-V Power-Supply Range
- $I_{off}$  Supports Partial-Power-Down Mode Operation
- I/Os Are 4.6-V Tolerant
- Latch-Up Performance Exceeds 100 mA Per JESD 78, Class II
- ESD Protection Exceeds JESD 22
  - 8000-V Human-Body Model (A114-A)
  - 200-V Machine Model (A115-A)
  - 1000-V Charged-Device Model (C101)

## DESCRIPTION/ORDERING INFORMATION

This 16-bit noninverting bus transceiver uses two separate configurable power-supply rails. The SN74AVC16T245 is optimized to operate with  $V_{CCA}/V_{CCB}$  set at 1.4 V to 3.6 V. It is operational with  $V_{CCA}/V_{CCB}$  as low as 1.2 V. The A port is designed to track  $V_{CCA}$ .  $V_{CCA}$  accepts any supply voltage from 1.2 V to 3.6 V. The B port is designed to track  $V_{CCB}$ .  $V_{CCB}$  accepts any supply voltage from 1.2 V to 3.6 V. This allows for universal low-voltage bidirectional translation between any of the 1.2-V, 1.5-V, 1.8-V, 2.5-V, and 3.3-V voltage nodes.

The SN74AVC16T245 is designed for asynchronous communication between data buses. The device transmits data from the A bus to the B bus or from the B bus to the A bus, depending on the logic level at the direction-control (DIR) input. The output-enable ( $\overline{OE}$ ) input can be used to disable the outputs so the buses effectively are isolated.

The SN74AVC16T245 is designed so that the control pins (1DIR, 2DIR,  $1\overline{OE}$ , and  $2\overline{OE}$ ) are supplied by  $V_{CCA}$ .

DGG OR DGV PACKAGE  
(TOP VIEW)

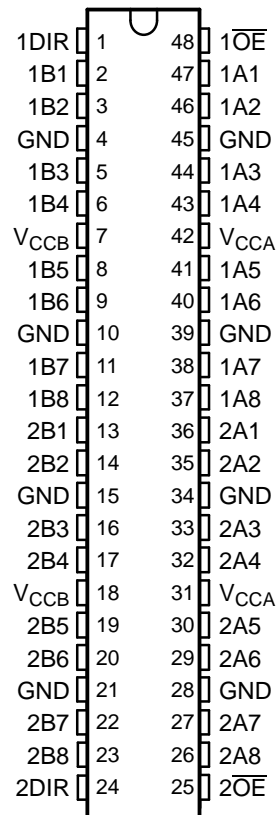

## ORDERING INFORMATION

$T_A$	PACKAGE <sup>(1)</sup>		ORDERABLE PART NUMBER	TOP-SIDE MARKING
–40°C to 85°C	TSSOP – DGG	Tape and reel	SN74AVC16T245DGGR	AVC16T245
	TVSOP – DGV	Tape and reel	SN74AVC16T245DGVR	WF245
	VFBGA – GQL	Tape and reel	SN74AVC16T245GQLR	WF245
	VFBGA – ZQL (Pb-free)		SN74AVC16T245ZQLR	

(1) Package drawings, standard packing quantities, thermal data, symbolization, and PCB design guidelines are available at [www.ti.com/sc/package](http://www.ti.com/sc/package).



Please be aware that an important notice concerning availability, standard warranty, and use in critical applications of Texas Instruments semiconductor products and disclaimers thereto appears at the end of this data sheet.

**SN74AVC16T245**  
**16-BIT DUAL-SUPPLY BUS TRANSCEIVER**  
**WITH CONFIGURABLE VOLTAGE TRANSLATION AND 3-STATE OUTPUTS**

SCES551C—FEBRUARY 2004—REVISED AUGUST 2005

**DESCRIPTION/ORDERING INFORMATION (CONTINUED)**

This device is fully specified for partial-power-down applications using  $I_{off}$ . The  $I_{off}$  circuitry disables the outputs, preventing damaging current backflow through the device when it is powered down.

The  $V_{CC}$  isolation feature ensures that if either  $V_{CC}$  input is at GND, both ports are in the high-impedance state.

To ensure the high-impedance state during power up or power down,  $\overline{OE}$  should be tied to  $V_{CC}$  through a pullup resistor; the minimum value of the resistor is determined by the current-sinking capability of the driver.

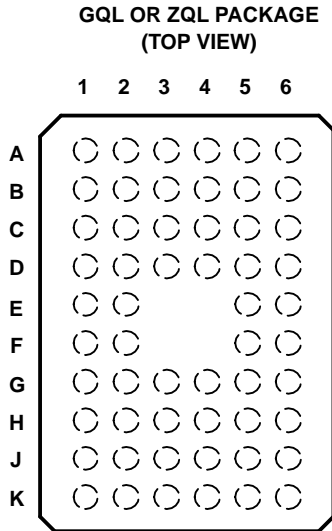

**TERMINAL ASSIGNMENTS<sup>(2)</sup>**

	1	2	3	4	5	6
<b>A</b>	1DIR	NC	NC	NC	NC	1 $\overline{OE}$
<b>B</b>	1B2	1B1	GND	GND	1A1	1A2
<b>C</b>	1B4	1B3	$V_{CCB}$	$V_{CCA}$	1A3	1A4
<b>D</b>	1B6	1B5	GND	GND	1A5	1A6
<b>E</b>	1B8	1B7			1A7	1A8
<b>F</b>	2B1	2B2			2A2	2A1
<b>G</b>	2B3	2B4	GND	GND	2A4	2A3
<b>H</b>	2B5	2B6	$V_{CCB}$	$V_{CCA}$	2A6	2A5
<b>J</b>	2B7	2B8	GND	GND	2A8	2A7
<b>K</b>	2DIR	NC	NC	NC	NC	2 $\overline{OE}$

(2) NC – No internal connection

**FUNCTION TABLE**  
(EACH 8-BIT SECTION)

INPUTS		OPERATION
$\overline{OE}$	DIR	
L	L	B data to A bus
L	H	A data to B bus
H	X	Isolation

**LOGIC DIAGRAM (POSITIVE LOGIC)**

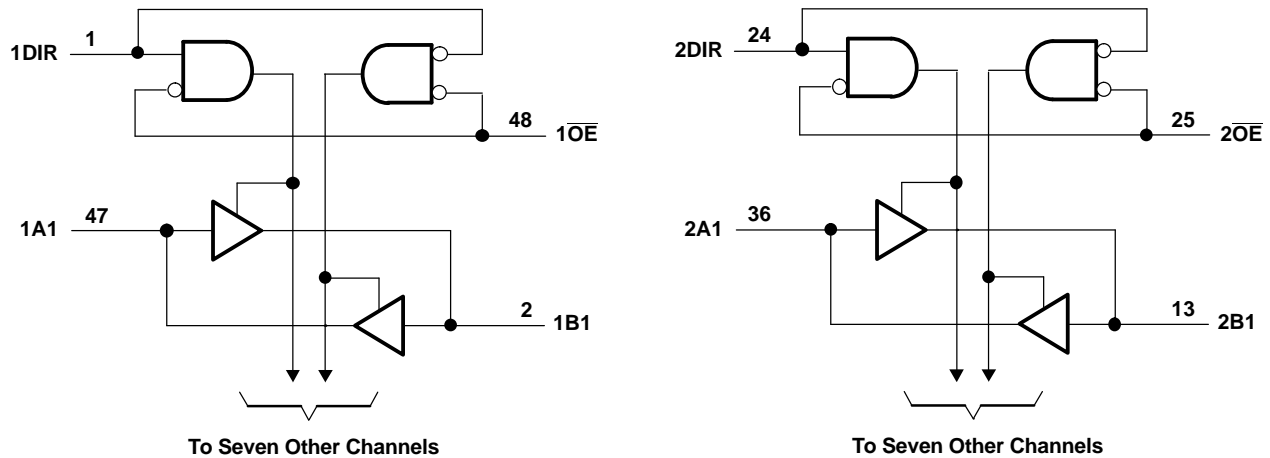

**Absolute Maximum Ratings<sup>(1)</sup>**

over operating free-air temperature range (unless otherwise noted)

		MIN	MAX	UNIT	
$V_{CCA}$ $V_{CCB}$	Supply voltage range	-0.5	4.6	V	
$V_I$	Input voltage range <sup>(2)</sup>	I/O ports (A port)	-0.5	4.6	V
		I/O ports (B port)	-0.5	4.6	
		Control inputs	-0.5	4.6	
$V_O$	Voltage range applied to any output in the high-impedance or power-off state <sup>(2)</sup>	A port	-0.5	4.6	V
		B port	-0.5	4.6	
$V_O$	Voltage range applied to any output in the high or low state <sup>(2)(3)</sup>	A port	-0.5	$V_{CCA} + 0.5$	V
		B port	-0.5	$V_{CCB} + 0.5$	
$I_{IK}$	Input clamp current	$V_I < 0$	-50	mA	
$I_{OK}$	Output clamp current	$V_O < 0$	-50	mA	
$I_O$	Continuous output current		±50	mA	
	Continuous current through each $V_{CCA}$ , $V_{CCB}$ , and GND		±100	mA	
$\theta_{JA}$	Package thermal impedance <sup>(4)</sup>	DGG package	70	°C/W	
		DGV package	58		
		GQL/ZQL package	42		
$T_{stg}$	Storage temperature range	-65	150	°C	

- (1) Stresses beyond those listed under "absolute maximum ratings" may cause permanent damage to the device. These are stress ratings only, and functional operation of the device at these or any other conditions beyond those indicated under "recommended operating conditions" is not implied. Exposure to absolute-maximum-rated conditions for extended periods may affect device reliability.
- (2) The input voltage and output negative-voltage ratings may be exceeded if the input and output current ratings are observed.
- (3) The output positive-voltage rating may be exceeded up to 4.6 V maximum if the output current rating is observed.
- (4) The package thermal impedance is calculated in accordance with JESD 51-7.

**SN74AVC16T245**  
**16-BIT DUAL-SUPPLY BUS TRANSCEIVER**  
**WITH CONFIGURABLE VOLTAGE TRANSLATION AND 3-STATE OUTPUTS**

SCES551C—FEBRUARY 2004—REVISED AUGUST 2005

**Recommended Operating Conditions**<sup>(1)(2)(3)</sup>

		$V_{CCI}$	$V_{CCO}$	MIN	MAX	UNIT
$V_{CCA}$	Supply voltage			1.2	3.6	V
$V_{CCB}$	Supply voltage			1.2	3.6	V
$V_{IH}$	High-level input voltage	Data inputs <sup>(4)</sup>	1.2 V to 1.95 V	$V_{CCI} \times 0.65$		V
			1.95 V to 2.7 V	1.6		
			2.7 V to 3.6 V	2		
$V_{IL}$	Low-level input voltage	Data inputs <sup>(4)</sup>	1.2 V to 1.95 V	$V_{CCI} \times 0.35$		V
			1.95 V to 2.7 V	0.7		
			2.7 V to 3.6 V	0.8		
$V_{IH}$	High-level input voltage	DIR (referenced to $V_{CCA}$ ) <sup>(5)</sup>	1.2 V to 1.95 V	$V_{CCA} \times 0.65$		V
			1.95 V to 2.7 V	1.6		
			2.7 V to 3.6 V	2		
$V_{IL}$	Low-level input voltage	DIR (referenced to $V_{CCA}$ ) <sup>(5)</sup>	1.2 V to 1.95 V	$V_{CCA} \times 0.35$		V
			1.95 V to 2.7 V	0.7		
			2.7 V to 3.6 V	0.8		
$V_I$	Input voltage			0	3.6	V
$V_O$	Output voltage	Active state		0	$V_{CCO}$	V
		3-state		0	3.6	
$I_{OH}$	High-level output current		1.2 V	-3		mA
			1.4 V to 1.6 V	-6		
			1.65 V to 1.95 V	-8		
			2.3 V to 2.7 V	-9		
			3 V to 3.6 V	-12		
$I_{OL}$	Low-level output current		1.2 V	3		mA
			1.4 V to 1.6 V	6		
			1.65 V to 1.95 V	8		
			2.3 V to 2.7 V	9		
			3 V to 3.6 V	12		
$\Delta t/\Delta v$	Input transition rise or fall rate				5	ns/V
$T_A$	Operating free-air temperature			-40	85	°C

(1)  $V_{CCI}$  is the  $V_{CC}$  associated with the data input port.

(2)  $V_{CCO}$  is the  $V_{CC}$  associated with the output port.

(3) All unused data inputs of the device must be held at  $V_{CCI}$  or GND to ensure proper device operation. Refer to the TI application report, *Implications of Slow or Floating CMOS Inputs*, literature number SCBA004.

(4) For  $V_{CCI}$  values not specified in the data sheet,  $V_{IH}$  min =  $V_{CCI} \times 0.7$  V,  $V_{IL}$  max =  $V_{CCI} \times 0.3$  V.

(5) For  $V_{CCA}$  values not specified in the data sheet,  $V_{IH}$  min =  $V_{CCA} \times 0.7$  V,  $V_{IL}$  max =  $V_{CCA} \times 0.3$  V.

### Electrical Characteristics<sup>(1)(2)</sup>

over recommended operating free-air temperature range (unless otherwise noted)

PARAMETER	TEST CONDITIONS	V <sub>CCA</sub>	V <sub>CCB</sub>	T <sub>A</sub> = 25°C			-40°C to 85°C		UNIT
				MIN	TYP	MAX	MIN	MAX	
V <sub>OH</sub>	I <sub>OH</sub> = -100 μA	V <sub>I</sub> = V <sub>IH</sub>	1.2 V to 3.6 V	1.2 V to 3.6 V			V <sub>CCO</sub> - 0.2		V
	I <sub>OH</sub> = -3 mA		1.2 V	1.2 V	0.95				
	I <sub>OH</sub> = -6 mA		1.4 V	1.4 V		1.05			
	I <sub>OH</sub> = -8 mA		1.65 V	1.65 V		1.2			
	I <sub>OH</sub> = -9 mA		2.3 V	2.3 V		1.75			
	I <sub>OH</sub> = -12 mA		3 V	3 V		2.3			
V <sub>OL</sub>	I <sub>OL</sub> = 100 μA	V <sub>I</sub> = V <sub>IL</sub>	1.2 V to 3.6 V	1.2 V to 3.6 V			0.2		V
	I <sub>OL</sub> = 3 mA		1.2 V	1.2 V	0.15				
	I <sub>OL</sub> = 6 mA		1.4 V	1.4 V		0.35			
	I <sub>OL</sub> = 8 mA		1.65 V	1.65 V		0.45			
	I <sub>OL</sub> = 9 mA		2.3 V	2.3 V		0.55			
	I <sub>OL</sub> = 12 mA		3 V	3 V		0.7			
I <sub>i</sub>	Control inputs	V <sub>I</sub> = V <sub>CCA</sub> or GND	1.2 V to 3.6 V	1.2 V to 3.6 V	±0.025	±0.25		±1	μA
I <sub>off</sub>	A or B port	V <sub>I</sub> or V <sub>O</sub> = 0 to 3.6 V	0 V	0 to 3.6 V	±0.1	±2.5		±5	μA
	A or B port		0 to 3.6 V	0 V	±0.5	±2.5		±5	
I <sub>OZ</sub> <sup>(3)</sup>	A or B port	V <sub>O</sub> = V <sub>CCO</sub> or GND, V <sub>I</sub> = V <sub>CCI</sub> or GND, OE = V <sub>IH</sub>	3.6 V	3.6 V	±0.5	±2.5		±5	μA
I <sub>CCA</sub>		V <sub>I</sub> = V <sub>CCI</sub> or GND, I <sub>O</sub> = 0	1.2 V to 3.6 V	1.2 V to 3.6 V				25	μA
			0 V	3.6 V				-5	
			3.6 V	0 V				25	
I <sub>CCB</sub>		V <sub>I</sub> = V <sub>CCI</sub> or GND, I <sub>O</sub> = 0	1.2 V to 3.6 V	1.2 V to 3.6 V				25	μA
			0 V	3.6 V				25	
			3.6 V	0 V				-5	
I <sub>CCA</sub> + I <sub>CCB</sub>		V <sub>I</sub> = V <sub>CCI</sub> or GND, I <sub>O</sub> = 0	1.2 V to 3.6 V	1.2 V to 3.6 V				45	μA
C <sub>i</sub>	Control inputs	V <sub>I</sub> = 3.3 V or GND	3.3 V	3.3 V	3.5				pF
C <sub>io</sub>	A or B port	V <sub>O</sub> = 3.3 V or GND	3.3 V	3.3 V	7				pF

(1) V<sub>CCO</sub> is the V<sub>CC</sub> associated with the output port.

(2) V<sub>CCI</sub> is the V<sub>CC</sub> associated with the input port.

(3) For I/O ports, the parameter I<sub>OZ</sub> includes the input leakage current.

**SN74AVC16T245**  
**16-BIT DUAL-SUPPLY BUS TRANSCEIVER**  
**WITH CONFIGURABLE VOLTAGE TRANSLATION AND 3-STATE OUTPUTS**



SCES551C—FEBRUARY 2004—REVISED AUGUST 2005

**Switching Characteristics**

over recommended operating free-air temperature range,  $V_{CCA} = 1.2\text{ V}$  (see Figure 11)

PARAMETER	FROM (INPUT)	TO (OUTPUT)	$V_{CCB} = 1.2\text{ V}$	$V_{CCB} = 1.5\text{ V}$	$V_{CCB} = 1.8\text{ V}$	$V_{CCB} = 2.5\text{ V}$	$V_{CCB} = 3.3\text{ V}$	UNIT
			TYP	TYP	TYP	TYP	TYP	
$t_{PLH}$	A	B	4.1	3.3	3	2.8	3.2	ns
$t_{PHL}$			4.1	3.3	3	2.8	3.2	
$t_{PLH}$	B	A	4.4	4	3.8	3.6	3.5	ns
$t_{PHL}$			4.4	4	3.8	3.6	3.5	
$t_{PZH}$	$\overline{OE}$	A	6.4	6.4	6.4	6.4	6.4	ns
$t_{PZL}$			6.4	6.4	6.4	6.4	6.4	
$t_{PZH}$	$\overline{OE}$	B	6	4.6	4	3.4	3.2	ns
$t_{PZL}$			6	4.6	4	3.4	3.2	
$t_{PHZ}$	$\overline{OE}$	A	6.6	6.6	6.6	6.6	6.8	ns
$t_{PLZ}$			6.6	6.6	6.6	6.6	6.8	
$t_{PHZ}$	$\overline{OE}$	B	6	4.9	4.9	4.2	5.3	ns
$t_{PLZ}$			6	4.9	4.9	4.2	5.3	

**Switching Characteristics**

over recommended operating free-air temperature range,  $V_{CCA} = 1.5\text{ V} \pm 0.1\text{ V}$  (see Figure 11)

PARAMETER	FROM (INPUT)	TO (OUTPUT)	$V_{CCB} = 1.2\text{ V}$	$V_{CCB} = 1.5\text{ V} \pm 0.1\text{ V}$		$V_{CCB} = 1.8\text{ V} \pm 0.15\text{ V}$		$V_{CCB} = 2.5\text{ V} \pm 0.2\text{ V}$		$V_{CCB} = 3.3\text{ V} \pm 0.3\text{ V}$		UNIT
			TYP	MIN	MAX	MIN	MAX	MIN	MAX	MIN	MAX	
$t_{PLH}$	A	B	3.6	0.5	6.2	0.5	5.2	0.5	4.1	0.5	3.7	ns
$t_{PHL}$			3.6	0.5	6.2	0.5	5.2	0.5	4.1	0.5	3.7	
$t_{PLH}$	B	A	3.3	0.5	6.2	0.5	5.9	0.5	5.6	0.5	5.5	ns
$t_{PHL}$			3.3	0.5	6.2	0.5	5.9	0.5	5.6	0.5	5.5	
$t_{PZH}$	$\overline{OE}$	A	4.3	1	10.1	1	10.1	1	10.1	1	10.1	ns
$t_{PZL}$			4.3	1	10.1	1	10.1	1	10.1	1	10.1	
$t_{PZH}$	$\overline{OE}$	B	5.6	1	10.1	0.5	8.1	0.5	5.9	0.5	5.2	ns
$t_{PZL}$			5.6	1	10.1	0.5	8.1	0.5	5.9	0.5	5.2	
$t_{PHZ}$	$\overline{OE}$	A	4.5	1.5	9.1	1.5	9.1	1.5	9.1	1.5	9.1	ns
$t_{PLZ}$			4.5	1.5	9.1	1.5	9.1	1.5	9.1	1.5	9.1	
$t_{PHZ}$	$\overline{OE}$	B	5.5	1.5	8.7	1.5	7.5	1	6.5	1	6.3	ns
$t_{PLZ}$			5.5	1.5	8.7	1.5	7.5	1	6.5	1	6.3	

### Switching Characteristics

over recommended operating free-air temperature range,  $V_{CCA} = 1.8 \text{ V} \pm 0.15 \text{ V}$  (see Figure 11)

PARAMETER	FROM (INPUT)	TO (OUTPUT)	$V_{CCB} = 1.2 \text{ V}$	$V_{CCB} = 1.5 \text{ V} \pm 0.1 \text{ V}$		$V_{CCB} = 1.8 \text{ V} \pm 0.15 \text{ V}$		$V_{CCB} = 2.5 \text{ V} \pm 0.2 \text{ V}$		$V_{CCB} = 3.3 \text{ V} \pm 0.3 \text{ V}$		UNIT
			TYP	MIN	MAX	MIN	MAX	MIN	MAX	MIN	MAX	
$t_{PLH}$	A	B	3.4	0.5	5.9	0.5	4.8	0.5	3.7	0.5	3.3	ns
$t_{PHL}$			3.4	0.5	5.9	0.5	4.8	0.5	3.7	0.5	3.3	
$t_{PLH}$	B	A	3	0.5	5.2	0.5	4.8	0.5	4.5	0.5	4.4	ns
$t_{PHL}$			3	0.5	5.2	0.5	4.8	0.5	4.5	0.5	4.4	
$t_{PZH}$	$\overline{OE}$	A	3.4	1	7.8	1	7.8	1	7.8	1	7.8	ns
$t_{PZL}$			3.4	1	7.8	1	7.8	1	7.8	1	7.8	
$t_{PZH}$	$\overline{OE}$	B	5.4	1	9.2	0.5	7.4	0.5	5.3	0.5	4.5	ns
$t_{PZL}$			5.4	1	9.2	0.5	7.4	0.5	5.3	0.5	4.5	
$t_{PHZ}$	$\overline{OE}$	A	4.2	1.5	7.7	1.5	7.7	1.5	7.7	1.5	7.7	ns
$t_{PLZ}$			4.2	1.5	7.7	1.5	7.7	1.5	7.7	1.5	7.7	
$t_{PHZ}$	$\overline{OE}$	B	5.2	1.5	8.4	1.5	7.1	1	5.9	1	5.7	ns
$t_{PLZ}$			5.2	1.5	8.4	1.5	7.1	1	5.9	1	5.7	

### Switching Characteristics

over recommended operating free-air temperature range,  $V_{CCA} = 2.5 \text{ V} \pm 0.2 \text{ V}$  (see Figure 11)

PARAMETER	FROM (INPUT)	TO (OUTPUT)	$V_{CCB} = 1.2 \text{ V}$	$V_{CCB} = 1.5 \text{ V} \pm 0.1 \text{ V}$		$V_{CCB} = 1.8 \text{ V} \pm 0.15 \text{ V}$		$V_{CCB} = 2.5 \text{ V} \pm 0.2 \text{ V}$		$V_{CCB} = 3.3 \text{ V} \pm 0.3 \text{ V}$		UNIT
			TYP	MIN	MAX	MIN	MAX	MIN	MAX	MIN	MAX	
$t_{PLH}$	A	B	3.2	0.5	5.6	0.5	4.5	0.5	3.3	0.5	2.8	ns
$t_{PHL}$			3.2	0.5	5.6	0.5	4.5	0.5	3.3	0.5	2.8	
$t_{PLH}$	B	A	2.6	0.5	4.1	0.5	3.7	0.5	3.3	0.5	3.2	ns
$t_{PHL}$			2.6	0.5	4.1	0.5	3.7	0.5	3.3	0.5	3.2	
$t_{PZH}$	$\overline{OE}$	A	2.5	0.5	5.3	0.5	5.3	0.5	5.3	0.5	5.3	ns
$t_{PZL}$			2.5	0.5	5.3	0.5	5.3	0.5	5.3	0.5	5.3	
$t_{PZH}$	$\overline{OE}$	B	5.2	0.5	9.4	0.5	7.3	0.5	5.1	0.5	4.5	ns
$t_{PZL}$			5.2	0.5	9.4	0.5	7.3	0.5	5.1	0.5	4.5	
$t_{PHZ}$	$\overline{OE}$	A	3	1	6.1	1	6.1	1	6.1	1	6.1	ns
$t_{PLZ}$			3	1	6.1	1	6.1	1	6.1	1	6.1	
$t_{PHZ}$	$\overline{OE}$	B	5	1	7.9	1	6.6	1	6.1	1	5.2	ns
$t_{PLZ}$			5	1	7.9	1	6.6	1	6.1	1	5.2	

**SN74AVC16T245**  
**16-BIT DUAL-SUPPLY BUS TRANSCEIVER**  
**WITH CONFIGURABLE VOLTAGE TRANSLATION AND 3-STATE OUTPUTS**

SCES551C—FEBRUARY 2004—REVISED AUGUST 2005

**Switching Characteristics**

over recommended operating free-air temperature range,  $V_{CCA} = 3.3 \text{ V} \pm 0.3 \text{ V}$  (see Figure 11)

PARAMETER	FROM (INPUT)	TO (OUTPUT)	$V_{CCB} = 1.2 \text{ V}$	$V_{CCB} = 1.5 \text{ V} \pm 0.1 \text{ V}$		$V_{CCB} = 1.8 \text{ V} \pm 0.15 \text{ V}$		$V_{CCB} = 2.5 \text{ V} \pm 0.2 \text{ V}$		$V_{CCB} = 3.3 \text{ V} \pm 0.3 \text{ V}$		UNIT
			TYP	MIN	MAX	MIN	MAX	MIN	MAX	MIN	MAX	
$t_{PLH}$	A	B	3.2	0.5	5.5	0.5	4.4	0.5	3.2	0.5	2.7	ns
$t_{PHL}$			3.2	0.5	5.5	0.5	4.4	0.5	3.2	0.5	2.7	
$t_{PLH}$	B	A	2.8	0.5	3.7	0.5	3.3	0.5	2.8	0.5	2.7	ns
$t_{PHL}$			2.8	0.5	3.7	0.5	3.3	0.5	2.8	0.5	2.7	
$t_{PZH}$	$\overline{OE}$	A	2.2	0.5	4.3	0.5	4.2	0.5	4.1	0.5	4	ns
$t_{PZL}$			2.2	0.5	4.3	0.5	4.2	0.5	4.1	0.5	4	
$t_{PZH}$	$\overline{OE}$	B	5.1	0.5	9.3	0.5	7.2	0.5	4.9	0.5	4	ns
$t_{PZL}$			5.1	0.5	9.3	0.5	7.2	0.5	4.9	0.5	4	
$t_{PHZ}$	$\overline{OE}$	A	3.4	0.5	5	0.5	5	0.5	5	0.5	5	ns
$t_{PLZ}$			3.4	0.5	5	0.5	5	0.5	5	0.5	5	
$t_{PHZ}$	$\overline{OE}$	B	4.9	1	7.7	1	6.5	1	5.2	0.5	5	ns
$t_{PLZ}$			4.9	1	7.7	1	6.5	1	5.2	0.5	5	

**Operating Characteristics**

$T_A = 25^\circ\text{C}$

PARAMETER			TEST CONDITIONS	$V_{CCA} = V_{CCB} = 1.2 \text{ V}$	$V_{CCA} = V_{CCB} = 1.5 \text{ V}$	$V_{CCA} = V_{CCB} = 1.8 \text{ V}$	$V_{CCA} = V_{CCB} = 2.5 \text{ V}$	$V_{CCA} = V_{CCB} = 3.3 \text{ V}$	UNIT
				TYP	TYP	TYP	TYP	TYP	
$C_{pdA}^{(1)}$	A to B	Outputs enabled	$C_L = 0,$ $f = 10 \text{ MHz},$ $t_r = t_f = 1 \text{ ns}$	1	1	1	1	2	pF
		Outputs disabled		1	1	1	1	1	
	B to A	Outputs enabled		13	13	14	15	16	
		Outputs disabled		1	1	1	1	1	
$C_{pdB}^{(1)}$	A to B	Outputs enabled	$C_L = 0,$ $f = 10 \text{ MHz},$ $t_r = t_f = 1 \text{ ns}$	13	13	14	15	16	pF
		Outputs disabled		1	1	1	1	1	
	B to A	Outputs enabled		1	1	1	1	2	
		Outputs disabled		1	1	1	1	1	

(1) Power dissipation capacitance per transceiver

**Table 1. Typical Total Static Power Consumption ( $I_{CCA} + I_{CCB}$ )**

$V_{CCB}$	$V_{CCA}$						UNIT
	0 V	1.2 V	1.5 V	1.8 V	2.5 V	3.3 V	
0 V	0	<0.5	<0.5	<0.5	<0.5	<0.5	$\mu\text{A}$
1.2 V	<0.5	<1	<1	<1	<1	1	
1.5 V	<0.5	<1	<1	<1	<1	1	
1.8 V	<0.5	<1	<1	<1	<1	<1	
2.5 V	<0.5	1	<1	<1	<1	<1	
3.3 V	<0.5	1	<1	<1	<1	<1	

TYPICAL CHARACTERISTICS

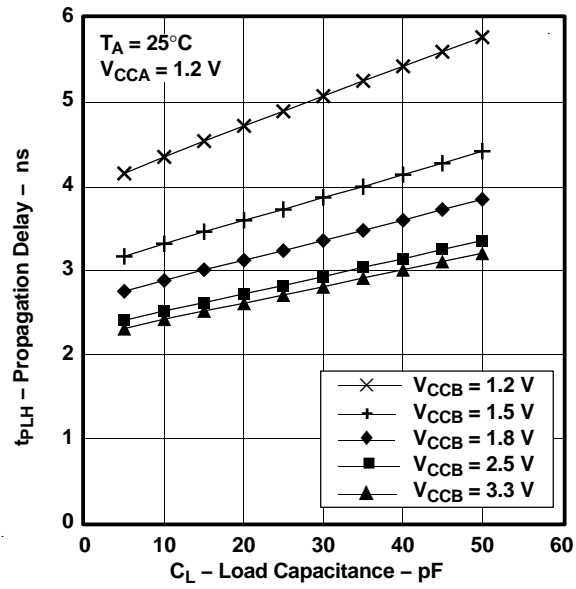

Figure 1.

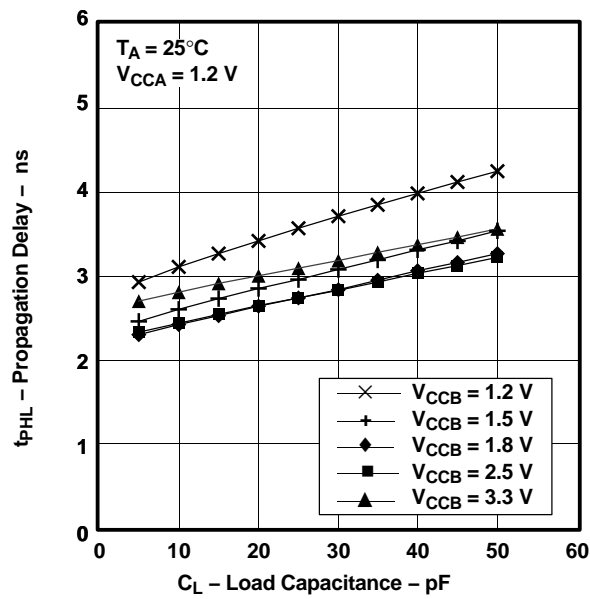

Figure 2.

**TYPICAL CHARACTERISTICS**

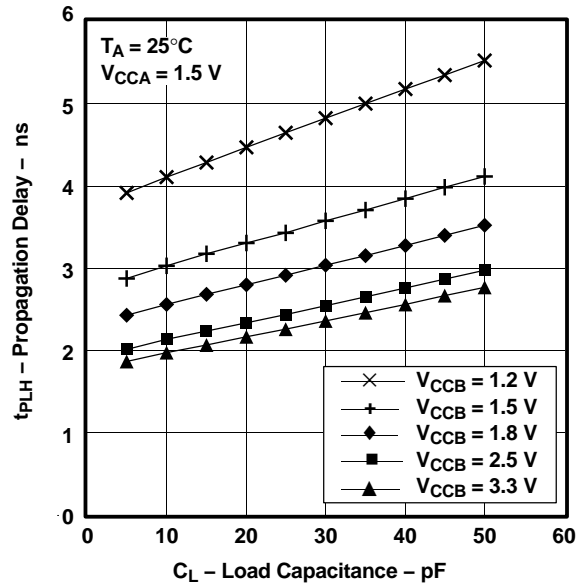

Figure 3.

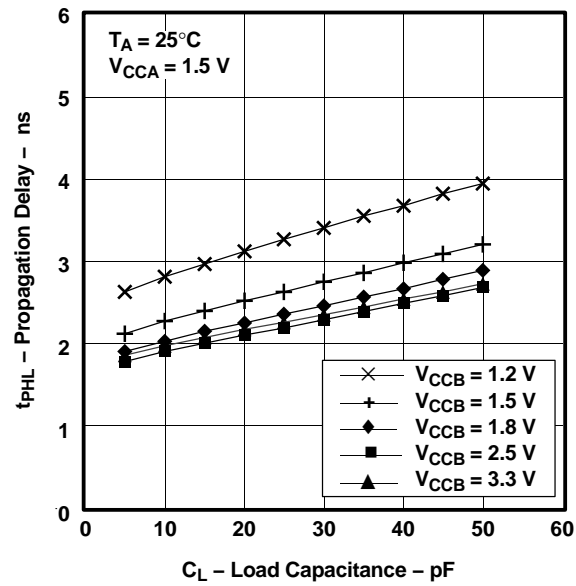

Figure 4.

TYPICAL CHARACTERISTICS

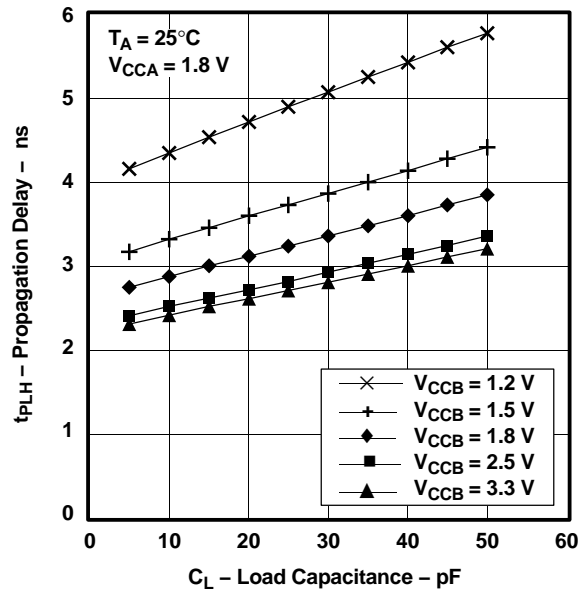

Figure 5.

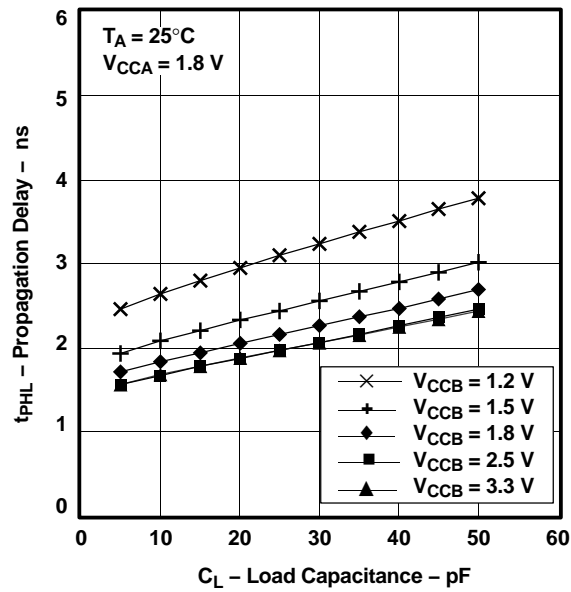

Figure 6.

**TYPICAL CHARACTERISTICS**

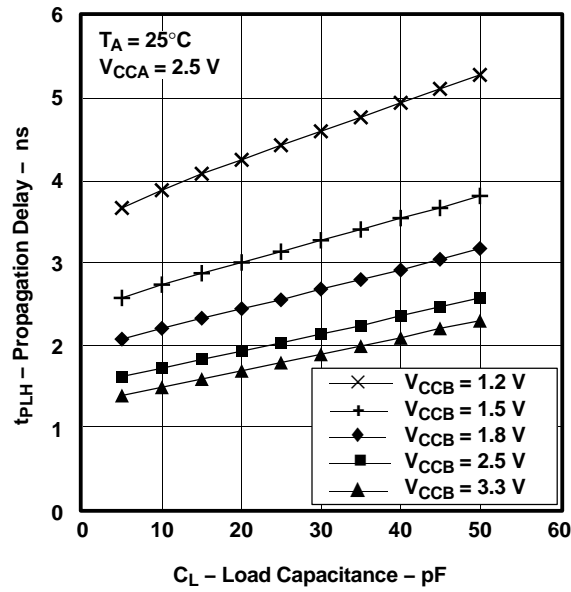

Figure 7.

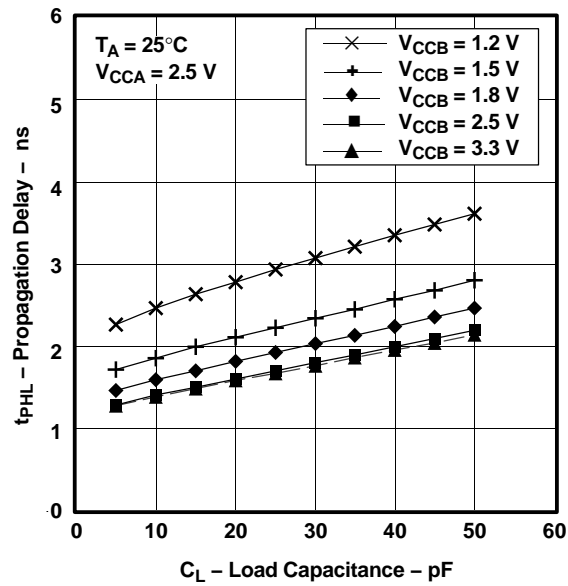

Figure 8.

TYPICAL CHARACTERISTICS

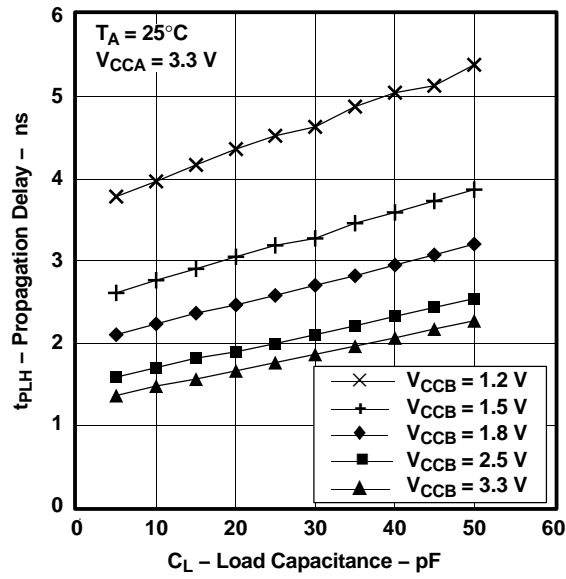

Figure 9.

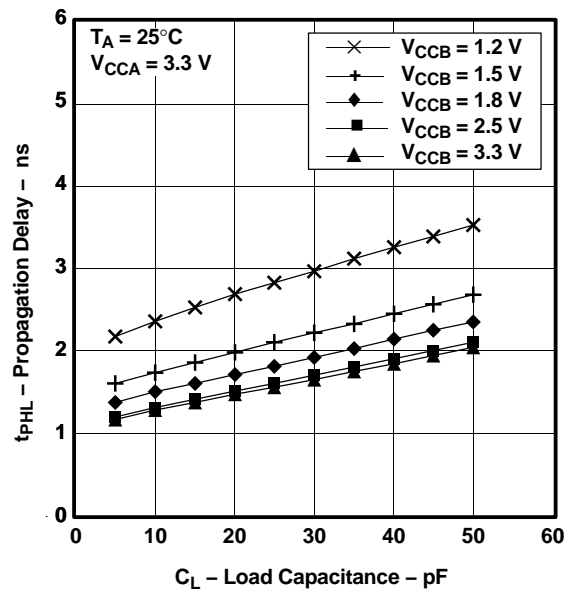
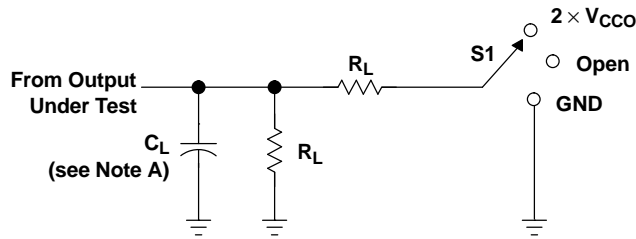

Figure 10.

PARAMETER MEASUREMENT INFORMATION



LOAD CIRCUIT

TEST	S1
$t_{pd}$	Open
$t_{PLZ}/t_{PZL}$	$2 \times V_{CCO}$
$t_{PHZ}/t_{PZH}$	GND

$V_{CCO}$	$C_L$	$R_L$	$V_{TP}$
1.2 V	15 pF	2 k $\Omega$	0.1 V
1.5 V $\pm$ 0.1 V	15 pF	2 k $\Omega$	0.1 V
1.8 V $\pm$ 0.15 V	15 pF	2 k $\Omega$	0.15 V
2.5 V $\pm$ 0.2 V	15 pF	2 k $\Omega$	0.15 V
3.3 V $\pm$ 0.3 V	15 pF	2 k $\Omega$	0.3 V

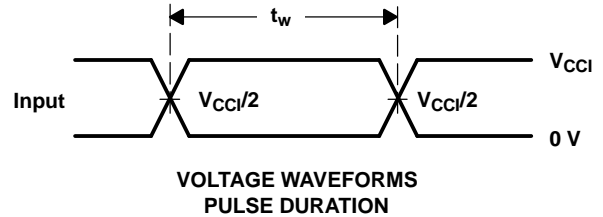

VOLTAGE WAVEFORMS  
PULSE DURATION

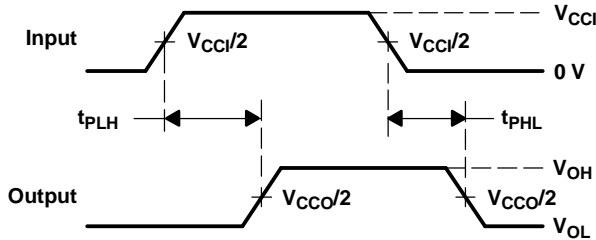

VOLTAGE WAVEFORMS  
PROPAGATION DELAY TIMES

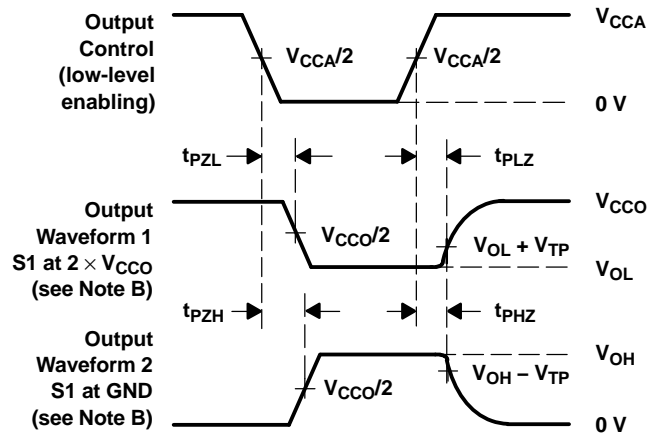

VOLTAGE WAVEFORMS  
ENABLE AND DISABLE TIMES

- NOTES: A.  $C_L$  includes probe and jig capacitance.  
 B. Waveform 1 is for an output with internal conditions such that the output is low, except when disabled by the output control. Waveform 2 is for an output with internal conditions such that the output is high, except when disabled by the output control.  
 C. All input pulses are supplied by generators having the following characteristics:  $PRR \leq 10$  MHz,  $Z_O = 50 \Omega$ ,  $dv/dt \geq 1$  V/ns.  
 D. The outputs are measured one at a time, with one transition per measurement.  
 E.  $t_{PLZ}$  and  $t_{PHZ}$  are the same as  $t_{dis}$ .  
 F.  $t_{PZL}$  and  $t_{PZH}$  are the same as  $t_{en}$ .  
 G.  $t_{PLH}$  and  $t_{PHL}$  are the same as  $t_{pd}$ .  
 H.  $V_{CCi}$  is the  $V_{CC}$  associated with the input port.  
 I.  $V_{CCO}$  is the  $V_{CC}$  associated with the output port.

Figure 11. Load Circuit and Voltage Waveforms

**PACKAGING INFORMATION**

Orderable Device	Status <sup>(1)</sup>	Package Type	Package Drawing	Pins	Package Qty	Eco Plan <sup>(2)</sup>	Lead/Ball Finish	MSL Peak Temp <sup>(3)</sup>
74AVC16T245DGGRE4	ACTIVE	TSSOP	DGG	48	2000	Green (RoHS & no Sb/Br)	CU NIPDAU	Level-1-260C-UNLIM
74AVC16T245DGVRE4	ACTIVE	TVSOP	DGV	48	2000	Green (RoHS & no Sb/Br)	CU NIPDAU	Level-1-260C-UNLIM
SN74AVC16T245DGGR	ACTIVE	TSSOP	DGG	48	2000	Green (RoHS & no Sb/Br)	CU NIPDAU	Level-1-260C-UNLIM
SN74AVC16T245DGVR	ACTIVE	TVSOP	DGV	48	2000	Green (RoHS & no Sb/Br)	CU NIPDAU	Level-1-260C-UNLIM
SN74AVC16T245GQLR	ACTIVE	VFBGA	GQL	56	1000	TBD	SNPB	Level-1-240C-UNLIM
SN74AVC16T245ZQLR	ACTIVE	VFBGA	ZQL	56	1000	Green (RoHS & no Sb/Br)	SNAGCU	Level-1-260C-UNLIM

<sup>(1)</sup> The marketing status values are defined as follows:

**ACTIVE:** Product device recommended for new designs.

**LIFEBUY:** TI has announced that the device will be discontinued, and a lifetime-buy period is in effect.

**NRND:** Not recommended for new designs. Device is in production to support existing customers, but TI does not recommend using this part in a new design.

**PREVIEW:** Device has been announced but is not in production. Samples may or may not be available.

**OBSOLETE:** TI has discontinued the production of the device.

<sup>(2)</sup> Eco Plan - The planned eco-friendly classification: Pb-Free (RoHS) or Green (RoHS & no Sb/Br) - please check <http://www.ti.com/productcontent> for the latest availability information and additional product content details.

**TBD:** The Pb-Free/Green conversion plan has not been defined.

**Pb-Free (RoHS):** TI's terms "Lead-Free" or "Pb-Free" mean semiconductor products that are compatible with the current RoHS requirements for all 6 substances, including the requirement that lead not exceed 0.1% by weight in homogeneous materials. Where designed to be soldered at high temperatures, TI Pb-Free products are suitable for use in specified lead-free processes.

**Green (RoHS & no Sb/Br):** TI defines "Green" to mean Pb-Free (RoHS compatible), and free of Bromine (Br) and Antimony (Sb) based flame retardants (Br or Sb do not exceed 0.1% by weight in homogeneous material)

<sup>(3)</sup> MSL, Peak Temp. -- The Moisture Sensitivity Level rating according to the JEDEC industry standard classifications, and peak solder temperature.

**Important Information and Disclaimer:**The information provided on this page represents TI's knowledge and belief as of the date that it is provided. TI bases its knowledge and belief on information provided by third parties, and makes no representation or warranty as to the accuracy of such information. Efforts are underway to better integrate information from third parties. TI has taken and continues to take reasonable steps to provide representative and accurate information but may not have conducted destructive testing or chemical analysis on incoming materials and chemicals. TI and TI suppliers consider certain information to be proprietary, and thus CAS numbers and other limited information may not be available for release.

In no event shall TI's liability arising out of such information exceed the total purchase price of the TI part(s) at issue in this document sold by TI to Customer on an annual basis.

ZQL (R-PBGA-N56)

PLASTIC BALL GRID ARRAY

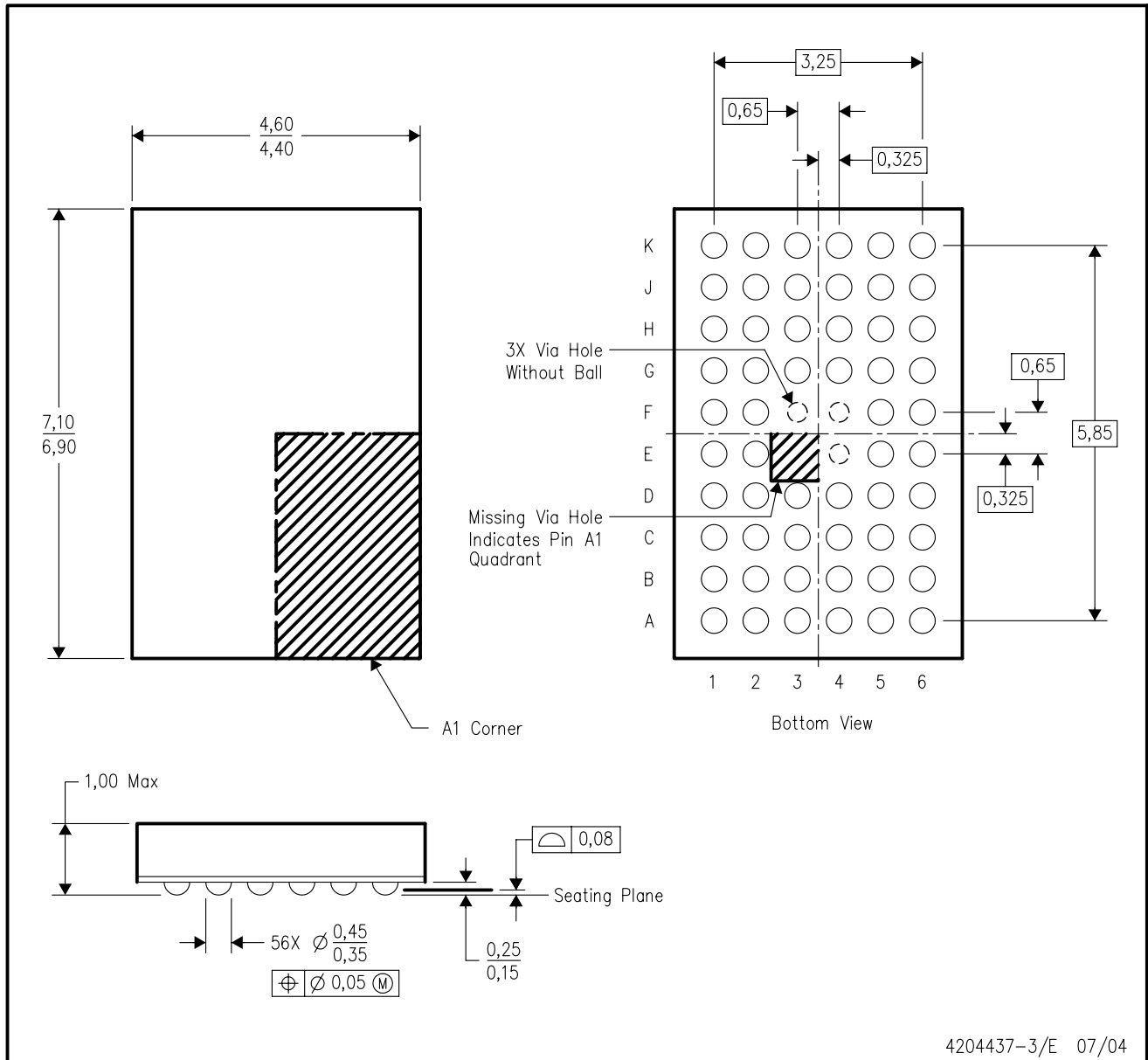

- NOTES:
- A. All linear dimensions are in millimeters.
  - B. This drawing is subject to change without notice.
  - C. Falls within JEDEC MO-225 variation BA.
  - D. This package is lead-free. Refer to the 56 GQL package (drawing 4200583) for tin-lead (SnPb).

DGV (R-PDSO-G\*\*)

PLASTIC SMALL-OUTLINE

24 PINS SHOWN



- NOTES: A. All linear dimensions are in millimeters.  
 B. This drawing is subject to change without notice.  
 C. Body dimensions do not include mold flash or protrusion, not to exceed 0,15 per side.  
 D. Falls within JEDEC: 24/48 Pins – MO-153  
 14/16/20/56 Pins – MO-194

GQL (R-PBGA-N56)

PLASTIC BALL GRID ARRAY

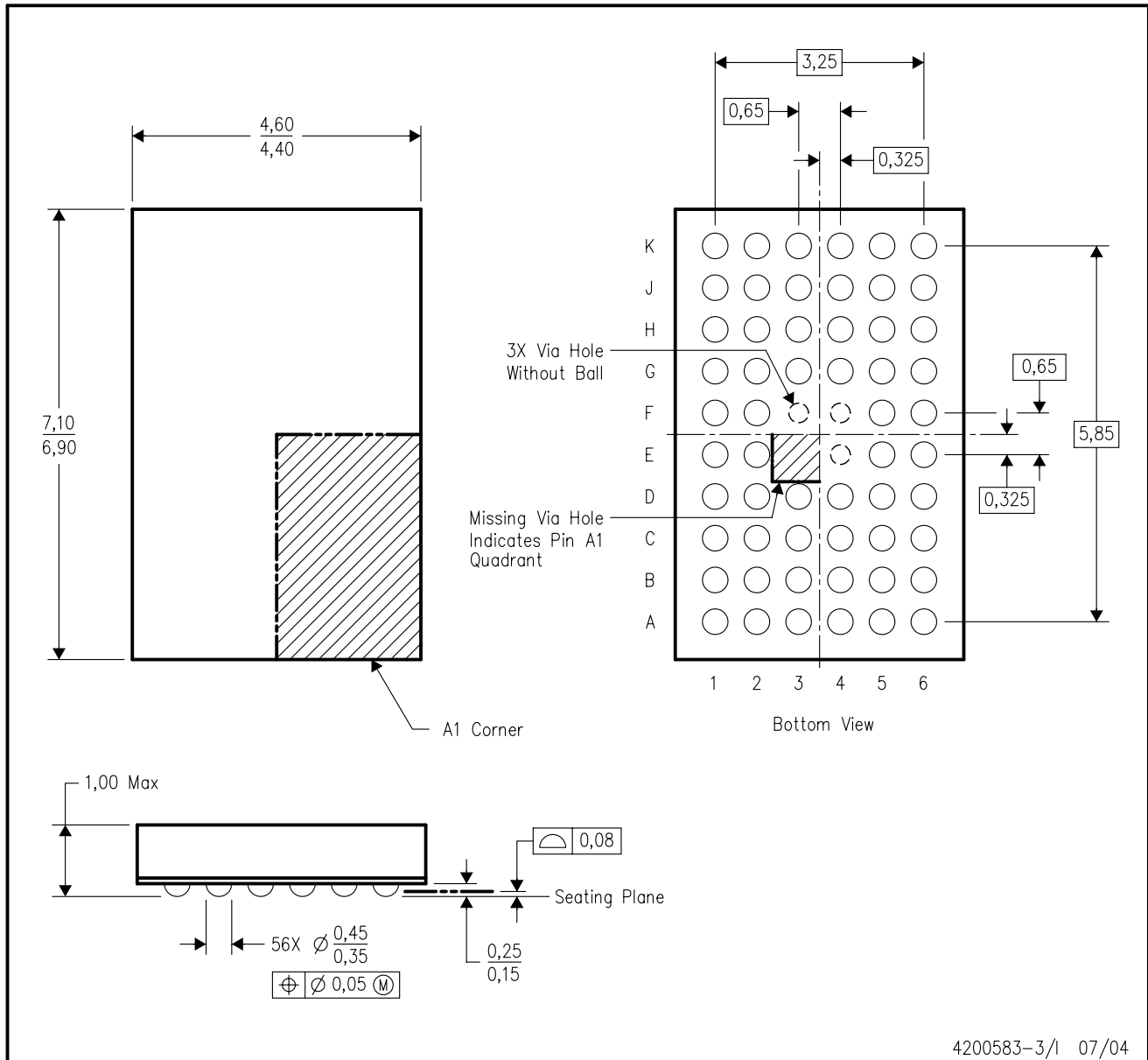

- NOTES:
- A. All linear dimensions are in millimeters.
  - B. This drawing is subject to change without notice.
  - C. Falls within JEDEC MO-225 variation BA.
  - D. This package is tin-lead (SnPb). Refer to the 56 ZQL package (drawing 4204437) for lead-free.

DGG (R-PDSO-G\*\*)

PLASTIC SMALL-OUTLINE PACKAGE

48 PINS SHOWN

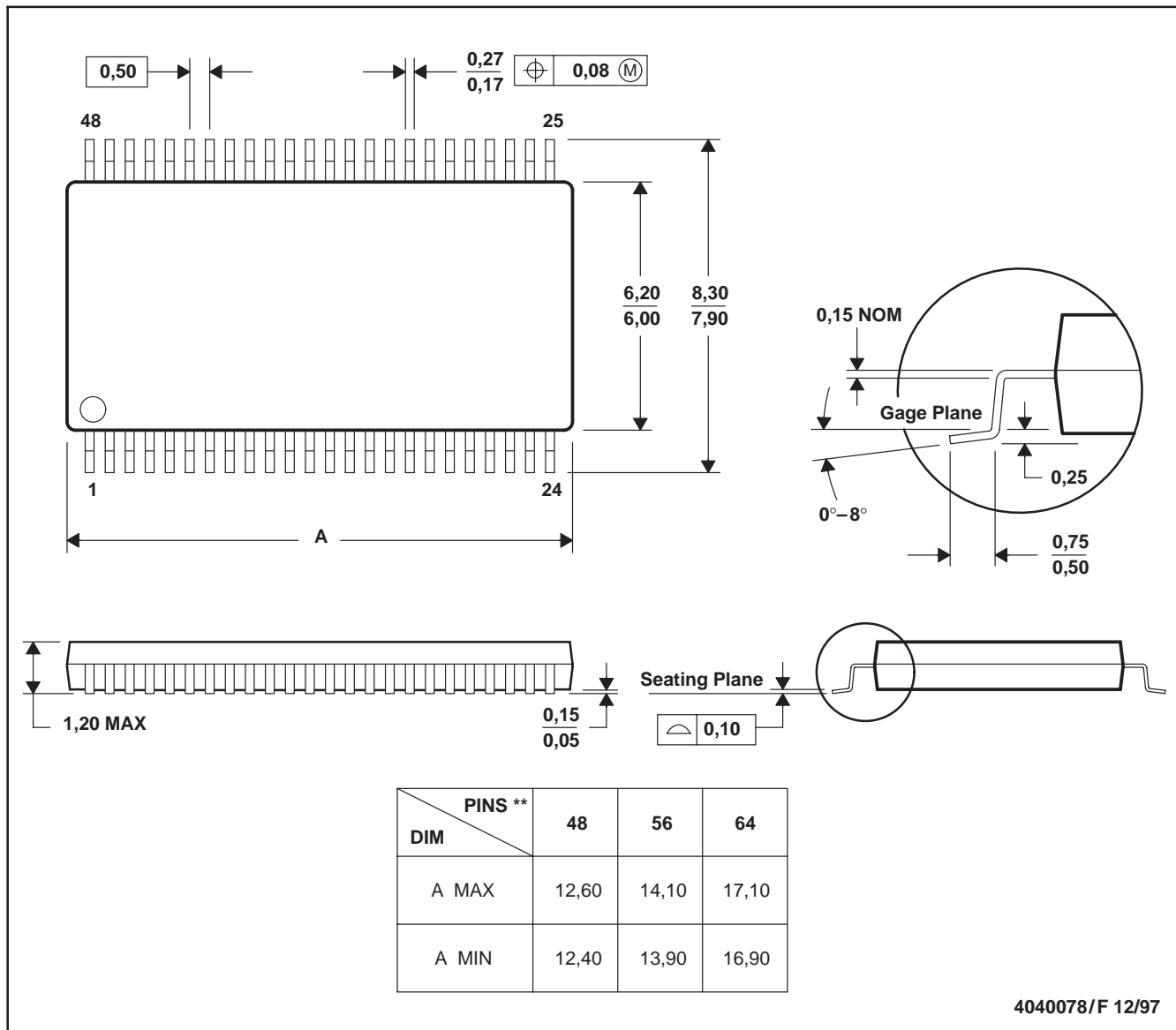

- NOTES: A. All linear dimensions are in millimeters.  
 B. This drawing is subject to change without notice.  
 C. Body dimensions do not include mold protrusion not to exceed 0,15.  
 D. Falls within JEDEC MO-153

## IMPORTANT NOTICE

Texas Instruments Incorporated and its subsidiaries (TI) reserve the right to make corrections, modifications, enhancements, improvements, and other changes to its products and services at any time and to discontinue any product or service without notice. Customers should obtain the latest relevant information before placing orders and should verify that such information is current and complete. All products are sold subject to TI's terms and conditions of sale supplied at the time of order acknowledgment.

TI warrants performance of its hardware products to the specifications applicable at the time of sale in accordance with TI's standard warranty. Testing and other quality control techniques are used to the extent TI deems necessary to support this warranty. Except where mandated by government requirements, testing of all parameters of each product is not necessarily performed.

TI assumes no liability for applications assistance or customer product design. Customers are responsible for their products and applications using TI components. To minimize the risks associated with customer products and applications, customers should provide adequate design and operating safeguards.

TI does not warrant or represent that any license, either express or implied, is granted under any TI patent right, copyright, mask work right, or other TI intellectual property right relating to any combination, machine, or process in which TI products or services are used. Information published by TI regarding third-party products or services does not constitute a license from TI to use such products or services or a warranty or endorsement thereof. Use of such information may require a license from a third party under the patents or other intellectual property of the third party, or a license from TI under the patents or other intellectual property of TI.

Reproduction of information in TI data books or data sheets is permissible only if reproduction is without alteration and is accompanied by all associated warranties, conditions, limitations, and notices. Reproduction of this information with alteration is an unfair and deceptive business practice. TI is not responsible or liable for such altered documentation.

Resale of TI products or services with statements different from or beyond the parameters stated by TI for that product or service voids all express and any implied warranties for the associated TI product or service and is an unfair and deceptive business practice. TI is not responsible or liable for any such statements.

Following are URLs where you can obtain information on other Texas Instruments products and application solutions:

<b>Products</b>		<b>Applications</b>	
Amplifiers	<a href="http://amplifier.ti.com">amplifier.ti.com</a>	Audio	<a href="http://www.ti.com/audio">www.ti.com/audio</a>
Data Converters	<a href="http://dataconverter.ti.com">dataconverter.ti.com</a>	Automotive	<a href="http://www.ti.com/automotive">www.ti.com/automotive</a>
DSP	<a href="http://dsp.ti.com">dsp.ti.com</a>	Broadband	<a href="http://www.ti.com/broadband">www.ti.com/broadband</a>
Interface	<a href="http://interface.ti.com">interface.ti.com</a>	Digital Control	<a href="http://www.ti.com/digitalcontrol">www.ti.com/digitalcontrol</a>
Logic	<a href="http://logic.ti.com">logic.ti.com</a>	Military	<a href="http://www.ti.com/military">www.ti.com/military</a>
Power Mgmt	<a href="http://power.ti.com">power.ti.com</a>	Optical Networking	<a href="http://www.ti.com/opticalnetwork">www.ti.com/opticalnetwork</a>
Microcontrollers	<a href="http://microcontroller.ti.com">microcontroller.ti.com</a>	Security	<a href="http://www.ti.com/security">www.ti.com/security</a>
		Telephony	<a href="http://www.ti.com/telephony">www.ti.com/telephony</a>
		Video & Imaging	<a href="http://www.ti.com/video">www.ti.com/video</a>
		Wireless	<a href="http://www.ti.com/wireless">www.ti.com/wireless</a>

Mailing Address: Texas Instruments  
Post Office Box 655303 Dallas, Texas 75265